

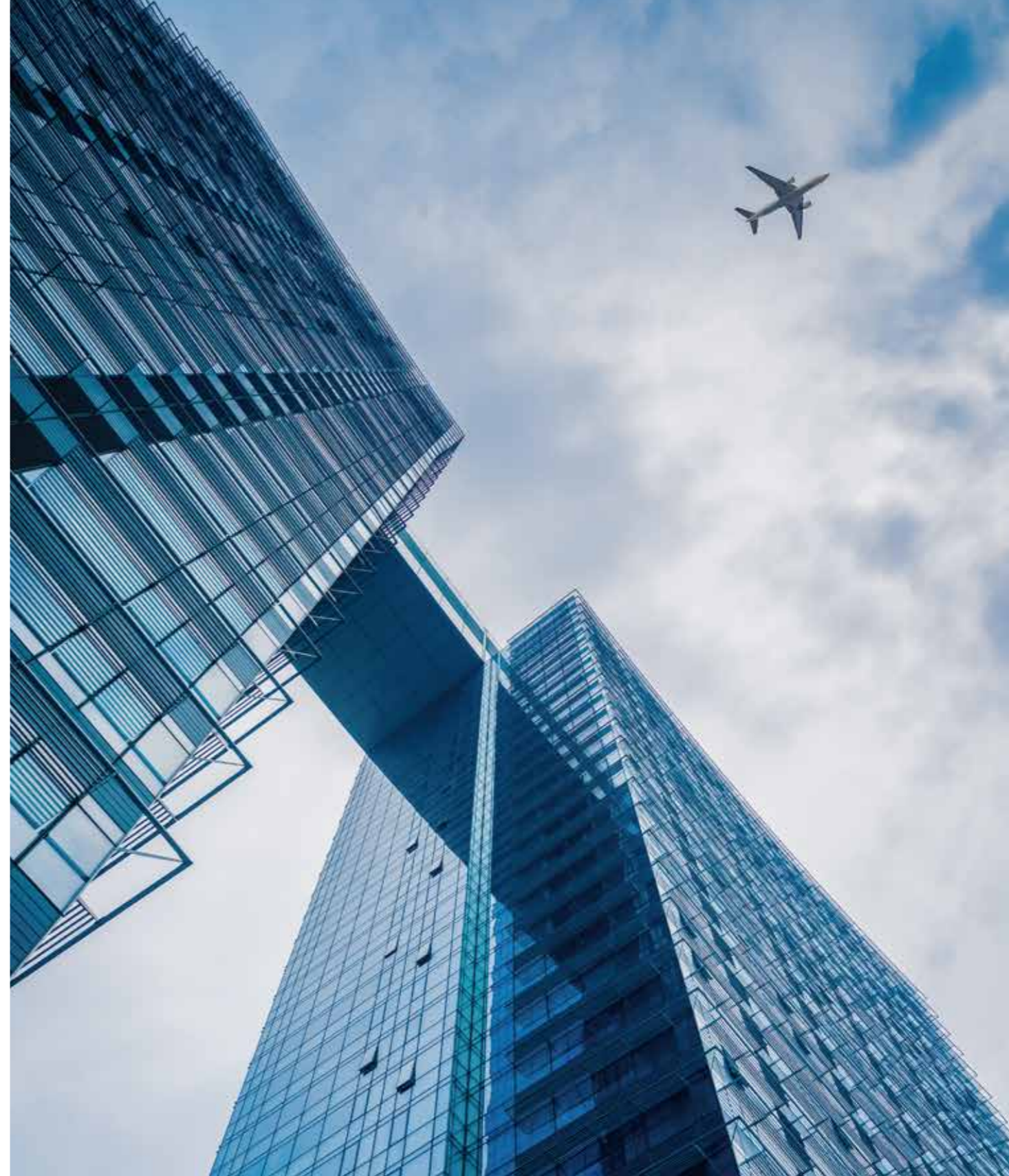

ICV TOTAL CONTROL INSIDE BUILDINGS



IC Valves (Nanjing) Co., Ltd.  
Changfa Centre Bldg A, 16G  
300 Zhongshan East Road  
Nanjing 210002, China

Tel: +86 25 8320 0100  
+86 25 8320 0020  
Fax: +86 25 8320 5225

info@icvalves.com  
www.icvalves.com  
www.avkvalves.com

2016-08  
Copyright IC Valves (Nanjing) Co., Ltd.



MEMBER OF THE **AVR** GROUP

BALANCING VALVES  
FOR BUILDING  
SERVICES



MEMBER OF THE **AVR** GROUP





## ICV™ - a proud member of the AVK Group

The AVK Group of Denmark is a privately owned industrial group that currently comprises 77 companies.

AVK's core business is the production of **valves, hydrants and accessories** for the water and gas distribution network, sewage treatment and fire protection. Furthermore, AVK has built up strong brands supplying valves and controls for water treatment, dams & reservoirs, buildings, HVAC, chemical processing, marine and other industrial sectors.

AVK best in class factories cast, machine, coat valves all over the world. AVK also produces its own sealing materials and other essential components in its own factories.

AVK products are designed to the major international standards and are sold in more than 80 countries worldwide. When dealing with the AVK Group expect quality, reliability, functionality and long lifetime in service.

ICV™ is a fully owned subsidiary of the AVK Group A/S.

**ICV™ (Indoor Climate Valves) is the building solution department** of the AVK Group.

Originally under the AVK Water segment the ICV business area was established as a separate AVK subsidiary brand in 2006 to allow for even greater focus on buildings.

ICV develops, produces, and markets all over the world - total valve solutions for buildings with valves produced by AVK.

This includes heating ventilation and air-conditioning (HVAC), drinking and wastewater in buildings

- General and manual valves (photo below)
- Motorized control valves (photo below)
- Balancing solutions (next page)

ICV's balancing solutions include all balancing valves typically used for buildings with innovative solutions and durable materials.





#### ICV Balancing Valves

- Flowmaster™ - PICV (p. 6-9)
- Deltacontrol™ - Differential pressure ctrl valves (p. 10-13)
- Deltaflow™ - Manual/static balancing valves (p. 14-17)
- Deltamatic™ Dynamic balancing valves (p. 18-21)
- Flowmaster™ FC MDBV for fan coils (p. 22-23)



# 951 Flowmaster™

## Pressure independent control valve - PICV

Offers the combined benefits of optimal modulating flow control valve, differential dynamic pressure balancing control, and manual balancing valve – all in one – for air-handling units, fresh air units, fan coils and all other terminal equipment.

ICV 951 Flowmaster™ PICV has been sold worldwide for years to the benefit of investors, designers, installers and users alike.

It's an integral part of ICV's balancing solution and is the optimal choice for all coils – particularly air handling units and fancoils.

ICV's 951 Flowmaster™ satisfies the need for static balancing caused by the construction of pipes and coils in hydraulic systems, as well the need for dynamic differential pressure balancing which occurs when control valves modulate the flow of water to terminal coils to adjust the temperature in rooms and thereby impact the flow to other terminal coils.

The motorized control valve is also built into the 951 - that's why called a 3-in-1.

### Design made fast and safe

- Simply and quickly chose the valve according to the designed flowrate
- The constant differential pressure control across the modulation control valve guarantees full valve authority at 100%.
- Security that the specified flow is also the actual flow
- Automatic adjustment if the system is modified after the initial installation – no rebalancing necessary
- Design pumps according the actual needs – no need to overdesign capacity

### Investments made easy

- One 3-in-1 valve replaces three other valves reducing material cost and installation time, no other regulating valves required when installed at terminals

### Installation made fast and easy

- Automatic balancing reduces the time required for debugging
- Minimized commissioning time due to automatic balancing of the system

### Comfort made safe

- Precise temperature control gives users better comfort and eliminates over or under supply regardless of fluctuating pressure conditions in the system
- Correct balancing minimizes actuator action extending its service life
- Fast response pressure regulator reduces energy consumption and increases system stability

### Highlights

#### Cost saving

A single 3-in-1 PICV replaces three other valves saving on investment and installation cost

#### Safe

Balancing made safe during design, installation and remodeling for designers and installers

#### Comfortable

Increased comfort for users due to ensured balancing and precise modulating temperature control

#### Energy saving

Inbuilt fast response balancing regulator reduces energy consumption and pump size

# Flowmaster™



Stroke modulation is ensured through large stroke size  
 Commissioning and flushing enabled without actuator  
 Designed to resist build-up of dirt  
 High quality materials ensures no corrosion

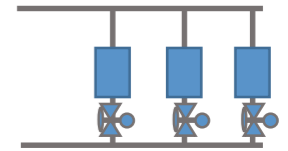

**Recommended application:**  
 The 951 PICV is installed on the return pipe of any terminal coil offering the combined benefits of optimal modulating flow control valve, differential dynamic pressure balancing control, and manual balancing valve – all in one – for air-handling units, fresh air units, fan coils and all other terminal equipment.

Full stroke modulation is ensured regardless of the presetting.  
 “First open” cap to allow for installation and commissioning before actuator is installed.  
 Removable pressure regulator cartridge makes small-pipe flushing and pipe cleaning easy  
 High quality DZR brass ensures no corrosion

									
Heating	ICV no	951-000-9804	951-000-9806	9200420248	9200420249				
Cooling	Force (Nm)	250N	400N	1200N	5000N				
Source	Running time (50/60Hz)	75	140	210/175	240/175				
Ventilation	IP Class	IP44	IP54	IP54	IP54				
24VAC		Control signal		Modulating 0-10V, 0..20mA, 2-10V/4..20mA, 2P on/off					
		Feedback (position) signal		0-10V, 2-10V					
PN25 0..120°C	ICV no	DN	Δps [kPa] Range	Kvs (m³/h)	Δps [kPa]	Δps [kPa]	Δps [kPa]	Δps [kPa]	
	951-015-2011	15 low	16-400	0.075 -0.625	400				Body: DZR Brass EN CW602N Regulator: PPS with 40% glass Flow limiter: PPO Spring: Stainless steel O-ring: EPDM Body: 89/336/EEC, 93/68/EEC
	951-020-2011	20 low	16 -400	0.131 -1.05	400				
	951-025-2011	25 low	16 -400	0.231 -1.722	300				
	951-015-2012	15	18 -400	0.244 -1.724	400				
	951-020-2012	20	22 -400	0.292 -2.039	300				
	951-025-2012	25	22 -400	0.292 -2.039	300				
	951-032-2012	32	18 -400	0.465 -3.056	300				
	951-040-2012	40	16 -400	2.022 -7.105		300			
951-050-2012	50	16 -400	2.204 -8.586		300				
PN16/25 -5...95°C	ICV no	DN	Δps [kPa] Range	Kvs (m³/h)	Δps [kPa]	Δps [kPa]	Δps [kPa]	Δps [kPa]	
	951-0040-15012X	40	30-400	1.0 -7.7			500		Body: ductile GG25 Stem: AISI 304 Diaphragm: EPDM Internals: brass Standards: BS EN 12266, 1092-2
	951-0050-15012X	50	30-400	2.0 -12.1			400		
	951-0065-15012X	65	30-400	3.0 -20.4			300		
	951-0080-15012X	80	30-400	5.0 -40.0			300		
	951-0100-15170X	100	30-400	10.0 -45.3				300	
	951-0125-15170X	125	30-400	15.0 -70.7				300	
	951-0150-15170X	150	30-400	20.0 -101.8				300	
	951-0200-15-70X	200	30-400	50.0 -360.0				150	

### Innovative solution



The preset and volumetric flow control functions in one component (left), and pressure regulator (right) –replaceable, compact and innovative

### Maximum flow limiter



Simple presetting of maximum volumetric flow by inbuilt dial in brass valve

### P/T Ports - Pressure testing ports

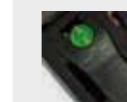

Safe and easy calibration of volumetric flow (Δp) using the ICV PFM Bluetooth commissioning instrument

### High grade materials



High grade materials: corrosion resistant brass, AVK rubber sealing, GG25 ductile iron ensures longevity

### Inbuilt pressure regulator



Very wide differential pressure control ranges 30-400kpa (dp<sub>min</sub> - dp<sub>max</sub>)  
 Very high constant flow precision at +/-5% of flowrate.

### Volumetric control valve



Precise volumetric flow control valve using ICV's 24V modulating actuators  
 100 valve authority ensured  
 Ensures temperature control and comfort to coil



# 908-3 Deltacontrol™

## Differential pressure controller

Offers precise and adjustable differential pressure balancing across flow and return pipes keeping the controlled area free of external pressure and flow fluctuations

ICV Deltacontrol™ 908-3 differential pressure control valve ensures a constant pressure difference between the supply and the return pipes of a building, a coil or a number of coils.

The controlled area will be protected from dynamic pressure and flow imbalances coming from outside the controlled area.

Deltacontrol™ 908-3 is a cost effective solution for branches with several coils where the internal pressure imbalance between coils is still acceptable. If there are only very few coils (i.e. AHU) or if the internal dynamic pressure imbalance between coils is unacceptable the Flowmaster™ is recommended.

Dynamic (changing) pressure imbalances occur in hydraulic systems when motorized control valves constantly modulate the

flow of water to coils (i.e. air handling units, fan coils etc.) to adjust the room temperature. This typically results in always changing (under/over) flows, greatly reducing comfort, wasting energy, and putting a strain on equipment and motorized control valves which have to constantly modulate to compensate - reducing their lifetime.

The differential pressure control principle is also applied in the Flowmaster™ 951 across the control valve itself (and thereby the individual coil) whereas the differential pressure controller usually balances a range of coils.

### Design made easy

- Wide offering from DN15-450 and very wide pressure balancing control ranges makes design safe and easy for risers, main pipes and all hydraulic branches
- Flexibility if the system is modified after the initial installation as pressure control ranges are adjustable

### Installation made cost effective and safe

- A single valve installed on the return pipe can control an entire branch which means installing fewer valves and saving time
- Flanged valves (DN50-450) are designed with nuts or feet underneath for easy placement without rolling over and unharmed transportation, installation and handling

### Operation made safe

- Noiseless operation.
- High comfort for the end-users provides the basis for accurate temperature control.
- Total water flow can be limited through better balancing by reducing the required pump head

### Highlights

#### Cost saving

A single valve balances an entire branch with many coils in it

#### Safe

Very wide range DN15-450 and wide pressure differentials (30-300 kPa) makes balancing safe during design, installation and remodeling for designers and installers

#### Comfortable

Increased comfort for users due to ensured balancing and precise modulating temperature control

#### Energy saving

Inbuilt fast response balancing regulator reduces energy consumption and pump size

# Deltacontrol™



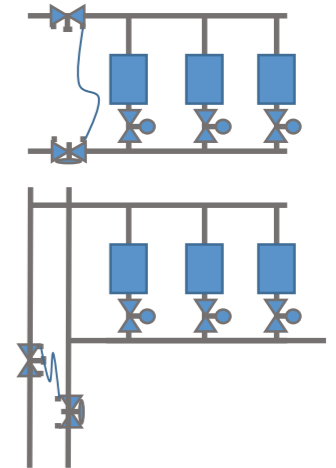
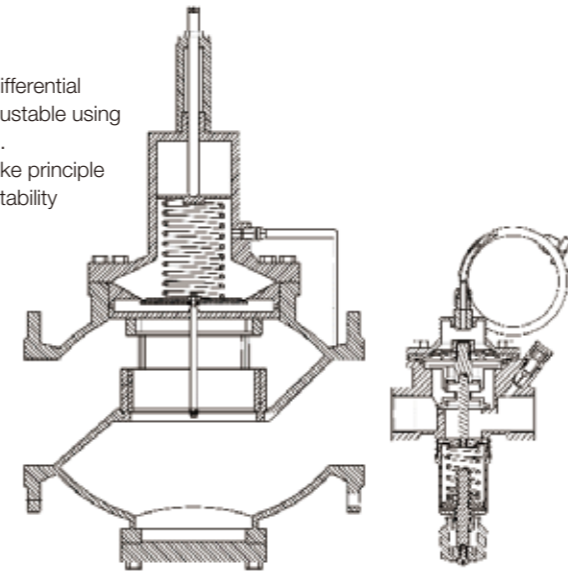

The required differential pressure is adjustable using the stem/knob. Design on stroke principle ensures high stability



### Recommended application:

The 908-3 differential pressure controller is installed on the return pipe and connected to the 908 manual balancing valve on the supply pipe through the copper tube. Offers precise and adjustable differential pressure balancing across flow and return pipes keeping the controlled hydraulic branch, building, or unit free of external pressure and flow fluctuations.

0 - 90°C	ICV No	DN	PN	$q_{min} / q_{nom} / q_{max}$	Control $\Delta p$ kPa	Working $\Delta p$ kPa	Main components and standards
	908-03-0015-1005	15	16	0.6/1.0/2.5	20 - 80	20 - 300	Body, seat, bonnet, tube: Brass H62 Diaphragm EPDM Spring: stainless steel AISI 30 Adjustment wheel: ABS BS 21 / BS EN 12266
	908-03-0020-1005	20	16	1.2/1.8/4.0	20 - 80	20 - 300	
	908-03-0032-1005	25	16	1.9/2.6/6.0	20 - 80	20 - 300	
	908-03-0032-1005	32	16	2.62/3.8/8.5	20 - 80	20 - 300	
	908-03-0040-1005	40	16	3.9/6.5/14.5	30 - 100	20 - 300	
	908-03-0050-1005	50	16	6.6/9.4/21	30 - 100	20 - 300	
0 - 100°C	ICV No (PN16/25)	DN	PN	$q_{min} / q_{nom} / q_{max}$	Control $\Delta p$ kPa	Working $\Delta p$ kPa	
	908-03-0050-1103/3103	50	16/25	2.0/17/32	10 - 300	30 - 300	Body, bonnet: ductile GGG40 Seat, disc, spring, stem: Stainless steel AISI 304 Diaphragm EPDM P/T port DZR Brass CW617N BS EN 12266/1092-2
	908-03-0065-1103/3103	65	16/25	2.0/17/32	10 - 300	30 - 300	
	908-03-0080-1103/3103	80	16/25	4.2/28/50	10 - 300	30 - 300	
	908-03-0100-1103/3103	100	16/25	5.5/40/80	10 - 300	30 - 300	
	908-03-0125-1103/3103	125	16/25	6.5/65/125	10 - 300	40 - 400	
	908-03-0150-1103/3103	150	16/25	8.0/90/160	10 - 300	40 - 400	
	908-03-0200-1103/3103	200	16/25	40/180/320	10 - 300	40 - 400	
	908-03-0250-1103/3103	250	16/25	xx/499/910	10 - 150	30 - 150	
	908-03-0300-1103/3103	300	16/25	xx/767/1400	10 - 150	30 - 150	
	908-03-0350-1103/3103	350	16/25	xx/959/1750	10 - 150	30 - 150	
	908-03-0400-1103/3103	400	16/25	xx/1542/2815	10 - 150	30 - 150	
	908-03-0450-1103/3103	450	16/25	xx/1991/3935	10 - 150	30 - 150	

\*  $Q_{nom}$  is the maximum theoretical flow at 100kPa

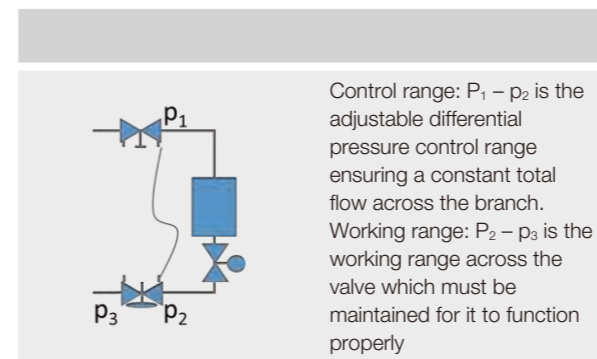

### High control accuracy in wide balancing range

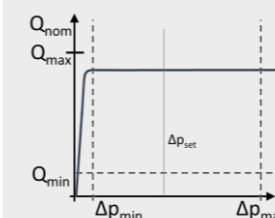

Deltaflow™ maintains a very precise +/-5% constant control  $\Delta p$  across the branch ( $p_1 - p_2$ ). The total flow of the modulating control valves is kept stable at whichever setpoint (Q) regardless of outside influences.

- ### P/T Ports - Pressure testing ports
- Safe and easy calibration of differential pressure flow ( $\Delta p$ ) using the ICV PFM Bluetooth commissioning instrument.
  - The flow rate and  $\Delta p$  matrix of ICV's balancing valves are in the database of the instrument ensuring correct and easy commissioning



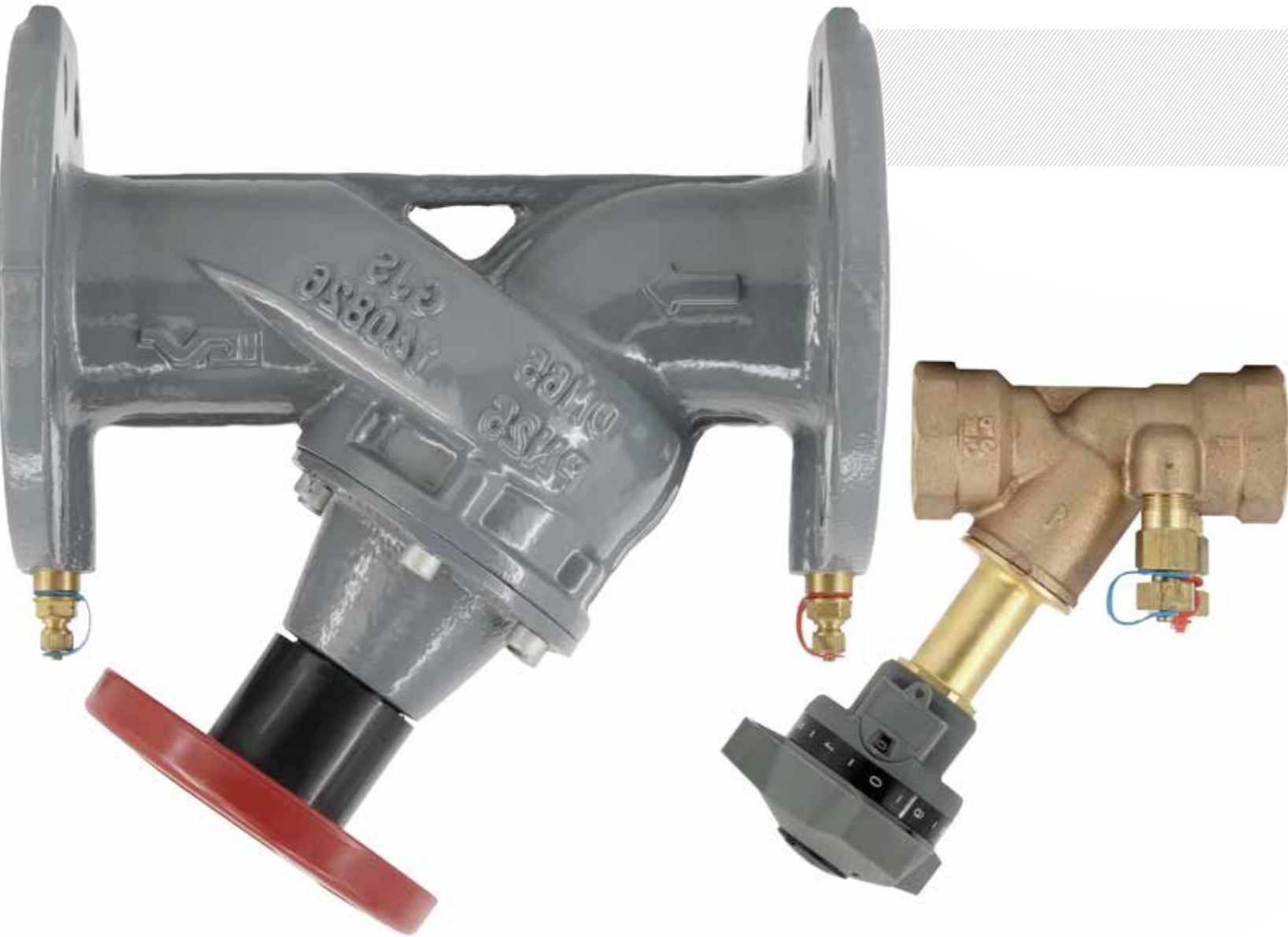

# 908 Deltaflow™

## Manual Balancing Valves from ICV

Offers precise control of maximum flow for static balancing between all sizes of piping and equipment across the entire hydraulic system

In hydraulic systems, static balancing is essential to ensuring that all coils and users in a hydraulic system receive the minimum required flow to maintain the desired room temperature.

Static (fixed) pressure imbalances are caused by uneven pressure drop (resistance) in different sizes and placement of pipes, coils and all other equipment in the hydraulic system. This typically means that larger equipment in an uncontrolled system close to the pump receives an oversupply while (smaller) equipment further away receives an underflow of energy.

Designers typically prefer to slightly oversize piping (to ensure supply safety in case of miscalculation and if the system

later is expanded) and then control the fixed pressure imbalances using manual balancing valves on risers, mains and branches.

ICV's manual balancing valves effectively solve the static pressure imbalances in the hydraulic system. The intelligent design ensures they do this precisely over the entire set-range of the valve. Static balancing valves solve the static pressure imbalances caused by the fixed equipment itself. To solve dynamic (changing) pressure imbalances mainly caused when motorized modulating control valves constantly adjust the flow to coils to adjust room temperature please install dynamic differential pressure controllers (908-3) or PICV's (951).

### Design made easy / fast and safe

- Wide range of solutions for hydraulic balancing (both static and dynamic) available makes design and selection safe and simple
- Precise visible measurement and scaling of flowrates means you get what you design
- Installation made fast and easy
- Easy to understand standardized flowrates and equal percentage design saves time and protects against installation mistakes
- Easy commissioning using ICV PFM Bluetooth commissioning tool means static balancing is simple and fast

### Investments made safe

- High grade materials and intelligent design ensures functionality and a lifetime longer than usual
- Reliable and precise functionality satisfies the user and protects against complaints and later needs for refurbishments

### Comfort made safe

- Precise static balancing ensures that all coils and users are protected against underflow receiving the necessary energy to maintain the desired comfort level
- Protects against overflow, resulting in lower cost and less wear on equipment

### Highlights

#### A safe investment

Very wide range of intelligently designed valves from DN15-400 using high grade materials

#### Easy installation

Precise and visible measurements and tamper protection, with added benefits of ICV's own PFM Bluetooth commissioning tool

#### Safe



Balancing made safe during design, installation and remodeling for designers and installers

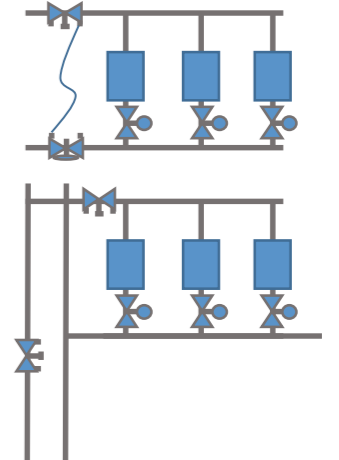

# Deltaflow™



**Recommended application:**  
Manual (static) balancing valves are installed on supply pipes to limit the maximum flow based on calculated flow requirements to avoid overflow which is not energy efficient and which would otherwise cause underflow in other parts of the system.

0 to 90°C	ICV No. PN25	DN	PN	Kvs max (m³/h)	Weight (kg)	
	908-02-0015-3	15	25	2.2	0.58	Body: bronze CC491K Bonnet: DZR Brass CW602N/ bronze CC491K (DN15-25/32-50) Stem, disc, ring, P/T ports: DZR brass CW602N Flow orifice, drive sleeve: brass EN CW617N Seat PTFE DN25-50, O rings: EPDM Standards testing: BS EN 12266-1&2, Thread: BS 21
	908-02-0020-3	20	25	4.6	0.65	
	908-02-0025-3	25	25	8.5	0.89	
	908-02-0032-3	32	25	16.7	1.11	
	908-02-0040-3	40	25	26.1	1.46	
	908-02-0050-3	50	25	43.2	1.98	
-10 to 110°C	ICV No. PN16/25	DN	PN	Kvs max (m³/h)	Weight (kg)	
	908-0065-00-136/736	65	16/25	83	13.00	Body, bonnet, plug (corrosion protected): ductile iron GJS-500-7 Stem: Stainless steel 1.4021 Sealing: NBR rubber P/T ports: DZR brass CW602N Flanges: EB558 Drilling standard EB1092 (ISO7005-2) Test: EN12266-1&2 Design: BS7350:1990 (PN16)
	908-0080-00-136/736	80	16/25	101	15.00	
	908-0100-00-136/736	100	16/25	200	22.00	
	908-0125-00-136/736	125	16/25	275	30.00	
	908-0150-00-136/736	150	16/25	385	42.00	
	908-0200-00-136/736	200	16/25	572	64.00	
	908-0250-00-136/736	250	16/25	1214	134.50	
	908-0300-00-136/736	300	16/25	1673	191.00	
	908-0350-00-136/736	350	16/25	2251	302.50	
	908-0400-00-136/736	400	16/25	2882	408.20	

### Product features

- Equal percentage control of flow matches the flow characteristics of the coils and motorized control valves
- Soft seat offers tight shut-off
- Feet on flanged valves for easy placement without rolling over and unharmed transportation, installation and handling
- External high quality surface fusion bonded epoxy coated
- Change of seal house O-ring during use possible at fully open valve position (back seating)
- Precise hand wheel with turn counter for easy reading and adjustment of the maximum flow rate

### Product features

- Locking device/max opening device integrated in stem protects against tampering causing unwanted static pressure imbalances
- Measuring ports for measuring differential pressure
- ICV PFM Bluetooth commissioning instrument measures the differential pressure and ensures safe and easy calibration of volumetric flow
- DN200-400 features pressure compensated design resulting in easier operation and lower lifecycle at higher flows and pressures

### Product features

- The fixed orifice ring of ICV threaded valves fixes the Kvs precisely - and measures the Kv value across the orifice achieving flow accuracy at ±5% regardless of valve opening. This is important for small valve sizes where small hand wheel changes have large relative impacts.
- Competing threaded valves have variable orifices and lower flow accuracy at small openings.

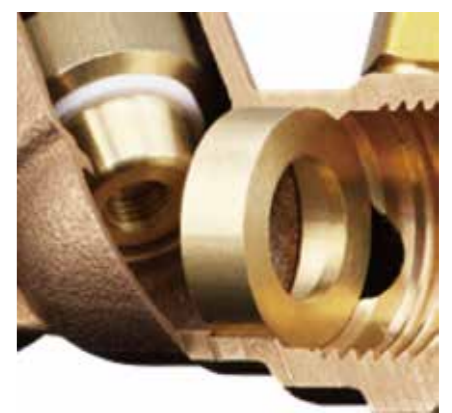



# Deltamatic™

## Dynamic Balancing Valves from ICV

Offers dynamic flow and maximum flow balancing ensuring that the flowrate after the valve is fixed and stable according to the chosen cartridge – for chillers and other equipment without modulating flow control requiring fixed flow supply. The ICV offering includes fixed orifice inserts ensuring that the valves also function as manual balancing valves.

The ICV Deltamatic Cartridges are designed and manufactured for the automatic balancing of heating and cooling circuits. ICV Automatic Balancing Products keep the flow constant at the specified level even under fluctuating pressure conditions.

From small size valves (DN15) to big wafer types (DN800), from small heating units to district cooling applications, there is an ICV Deltamatic Cartridge that can guarantee the specified flow to +/-5% of that specified and +/-10% for large sizes.

The advanced patented design of the ICV Deltamatic Cartridges introduces the orifice plate concept for higher performance and flexibility.

With ICV Deltamatic Cartridges it is no longer necessary to change the cartridge every time the design flow is modified. Each cartridge contains an orifice plate specific to the desired flow that can be easily removed and replaced by another one if design criteria change after purchase. Replacement cartridges and orifice plates will be held in stock locally.

- Only one differential pressure operating range (up to 600kPa) making the sizing of the cartridge very easy, (depending only on the design flow).
- Complete, broad and well-balanced distribution of flows for the full range of heating and cooling applications, (from 0.007 l/s and 7 kPa minimum  $\Delta P$ , to 11.381 l/s, per cartridge).
- Minimized friction and noise due to the patented cartridge design – the rolling diaphragm prevents metal-metal contact as the piston moves in and out, giving totally silent operation. This is a unique and extremely important feature.
- Improved response to water hammer due to shock absorption of the rubber diaphragm within the cartridge.
- No impact of debris on the performance of the cartridge. The design of the inlet and the outlet areas minimizes the accumulation of particles inside the cartridge.

### Design made easy

- Less time to define the necessary equipment for a hydraulic balanced system.
- No impact if the calculated distribution of pressure in the installation is not accurate.
- Security that the specified flow is also the real one.
- Flexibility if the system is modified after the initial installation.

### Installation made easy

- Cartridge solution makes flushing procedure very easy.
- Quick and easy installation of the cartridge in the valve.
- Minimized commissioning time due to automatic balancing of the system.

### Operation made safe

- Unproblematic performance even with high concentration of debris.
- Noiseless operation.
- High comfort for the end-users – provides accurate temperature control.
- Very precise flow control:

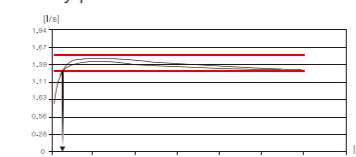

Schematic view of the flow development for cartridge type 40, 952-000-4014176. Nominal flow 1.388 l/s (+/-5% red lines). The cartridge is in the pressure range at 23-600kPa.

### Highlights

#### Precise

Precise flow control balancing for constant flow and on/off applications

#### Silent

ICV special internal diaphragm ensures silent operation preferred for hotels and homes





#### Complete

Easy and safe design, installation and investment with ICV's very wide range of sizes and pressure ratings

#### Durable and self-cleaning

Made to last with durable materials and innovative solutions

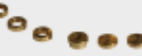
# Deltamatic™

-20°C to 120°C dP <sub>max</sub> (600/350 kPa)	DN15-25 PN25	ICV No. (L/H)			ICV No. (L/H)			
		Flow (l/s)	Min Δp (kPa)	AVK No. (L/H)	Flow (l/s)	Min Δp (kPa)		
	952-15-20-10 952-20-20-10 952-25-20-10	952-10 1 1150	0.007	7	952-11 1/2 1725	0.171	14	
		952-10 1 1170	0.01	7	952-11 1/2 1730	0.186	14	
		952-10 1 1190	0.012	7	952-11 1/2 1735	0.204	14	
		952-10 1/2 1210	0.015	7	952-11 1/2 1740	0.222	16	
		952-10 1/2 1230	0.021	8	952-11 1/2 1745	0.242	19	
		952-10 1/2 1260	0.024	9	952-11 1/2 1750	0.26	21	
		952-10 1/2 1290	0.029	10	<b>AVK No. (L/H)</b>	<b>Flow (l/s)</b>	<b>Min Δp (kPa)</b>	
		952-10 1/2 1300	0.032	10	952-20 1/2 2070	0.283	22	
		952-10 1/2 1320	0.036	11	952-20 1/2 2074	0.3	22	
		952-10 1/2 1350	0.043	11	952-20 1/2 2077	0.332	22	
		952-10 1/2 1370	0.049	12	952-20 1/2 2082	0.371	23	
		952-10 1/2 1400	0.057	12	952-20 1/2 2086	0.412	23	
		952-10 1/2 1430	0.067	12	952-20 1/2 2088	0.439	23	
		952-10 1/2 1460	0.078	12	952-20 1/2 2092	0.493	24	
		952-10 1/2 1490	0.089	13	952-20 1/2 2094	0.509	24	
		952-10 1/2 1510	0.097	13	952-20 1/2 2099	0.578	25	
		952-10 1/2 1540	0.111	13	952-20 1/2 2103	0.625	26	
		952-10 1/2 1570	0.132	14	952-20 1/2 2106	0.644	27	
		952-10 1/2 1620	0.151	14	952-20 1/2 2109	0.68	28	
			DN32-50	ICV No. (L/H)	Flow (l/s)	Min Δp (kPa)	ICV No. (L/H)	Flow (l/s)
	952-32-20-10 952-40-20-10 952-50-20-10	952-30 1/2 3073	0.188	12	952-40 1/2 4148	1.009	20	
		952-30 1/2 3082	0.239	12	952-40 1/2 4152	1.072	21	
		952-30 1/2 3089	0.283	12	952-40 1/2 4156	1.136	21	
		952-30 1/2 3094	0.315	12	952-40 1/2 4164	1.199	21	
		952-30 1/2 3096	0.331	12	952-40 1/2 4168	1.262	22	
		952-30 1/2 3098	0.353	13	952-40 1/2 4173	1.325	22	
		952-30 1/2 3102	0.375	13	952-40 1/2 4176	1.388	23	
		952-30 1/2 3107	0.413	13	952-40 1/2 4182	1.514	24	
		952-30 1/2 3111	0.435	14	952-40 1/2 4191	1.64	25	
		952-30 1/2 3112	0.453	14	952-40 1/2 4194	1.766	26	
		952-30 1/2 3118	0.504	14	952-40 1/2 4200	1.893	27	
		952-30 1/2 3124	0.556	15	952-40 1/2 4205	2.019	28	
		952-30 1/2 3125	0.568	16	952-40 1/2 4211	2.145	30	
		952-30 1/2 3129	0.603	16	952-40 1/2 4217	2.271	31	
		952-30 1/2 3132	0.631	17	952-40 1/2 4222	2.397	33	
		952-30 1/2 3135	0.661	17	952-40 1/2 4229	2.523	34	
		952-30 1/2 3138	0.694	18	952-40 1/2 4235	2.65	36	
		952-30 1/2 3142	0.733	18	952-40 1/2 4241	2.776	38	
		952-30 1/2 3148	0.797	19	952-40 1/2 4248	2.902	40	
		952-30 1/2 3156	0.886	21	952-40 1/2 4250	3.028	42	
952-30 1/2 3161	0.946	22	952-40 1/2 4262	3.154	44			
	ICV No.	DN	Types					
	ORIFICE P TYPE 10	952-XXXX	15-25	0.007-0.151				
	ORIFICE P TYPE 11	952-XXXX	15-25	0.171-0.260				
	ORIFICE P TYPE 20	952-XXXX	15-25	0.283-0.680				
	ORIFICE P TYPE 30	952-XXXX	32-50	0.188-0.968				
	ORIFICE P TYPE 40	952-XXXX	32-50	1.009-3.154				
	ICV No.	DN						
	LOCKING RING FOR 10/11/20	952-0000-11	15-25					
	LOCKING RING FOR 30/40	952-0000-31	32-50					

## 952 DN15-50:

- Valve and cartridge: DZR Brass to EN CW602N
- Diaphragm: (reinforced) HNBR(LP/HP)
- O-rings: EPDM
- Pressure class: PN25
- Temperature: -20°C to 120°C
- Diff. differential pressure: 7-600 kPa
- Thread: ISO 228

## 953 DN50-800 housing

- Body: ductile iron DIN 1693 GGG-40
- Cartridge: SS304/316
- O-rings: EPDM
- Fasteners: AISI 306
- Pressure class: PN16 (PN25)
- Temperature: -20°C to 110°C
- Diff. differential pressure: 13-600 kPa

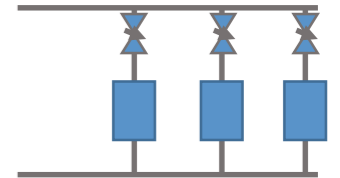

## Recommended application:

- Installed on the supply pipe of equipment needing constant flow (i.e. refrigeration water for chillers).
- Balances the dynamic and static differential pressure and supply for equipment by ensuring a constant flow. May be installed in conjunction with motorized on/off valves but not typically with modulating motorized control valves.

## Cartridges for Automatic Balancing Valve DN50-800, Deltamatic

-20 C to 120 C	DN50-800 PN25	Maxpcs	ICV No. (SS304/316)	Flow (l/s)	Min Δp (kPa)	ICV No.(SS304/316)	Flow (l/s)	Min Δp (kPa)
			953-50 1/2 5179	1.061	13	953-60 1/2 6285	4.733	34
			953-50 1/2 5184	1.092	13	953-60 1/2 6292	5.041	34
			953-50 1/2 5189	1.125	13	953-60 1/2 6301	5.221	35
			953-50 1/2 5194	1.167	13	953-60 1/2 6305	5.408	35
			953-50 1/2 5200	1.222	13	953-60 1/2 6312	5.684	35
			953-50 1/2 5206	1.289	14	953-60 1/2 6319	5.98	36
			953-50 1/2 5213	1.375	14	953-60 1/2 6326	6.236	36
			953-50 1/2 5220	1.475	14	953-60 1/2 6332	6.523	36
			953-50 1/2 5227	1.583	14	953-60 1/2 6338	6.815	37
			953-50 1/2 5235	1.725	14	953-60 1/2 6344	7.117	38
			953-50 1/2 5243	1.808	14	953-60 1/2 6349	7.369	38
			953-50 1/2 5251	1.967	14	953-60 1/2 6356	7.69	38
			953-50 1/2 5260	2.194	15	953-60 1/2 6362	8.099	38
			953-50 1/2 5269	2.472	16	953-60 1/2 6367	8.32	39
			953-50 1/2 5279	2.889	19	953-60 1/2 6373	8.605	39
			953-50 1/2 5287	3.154	22	953-60 1/2 6379	8.961	40
			953-50 1/2 5292	3.47	23	953-60 1/2 6385	9.324	40
			953-50 1/2 5298	3.722	24	953-60 1/2 6391	9.709	40
			953-50 1/2 5303	4.1	27	953-60 1/2 6393	10.093	42
			953-50 1/2 5308	4.444	29	953-60 1/2 6398	10.468	43
			953-60 1/2 6400	10.724	44			
			953-60 1/2 6407	11.381	46			
			953-60 1/2 6408	12.500	49			
Accessories	ICV No.	Accessories	ICV No.					
BLIND PLUG	953-001-0000	LOCKING RING FOR CAR. DN50-80	953-00-100					
CAR. BODY TYPE 50 HP	953-501-0000	BOLT M10*20	953-00-2001					
CAR. BODY TYPE 60 HP	953-601-0000	SLICE Ø25 * Ø10	953-00-2002					
ORIFICE P TYPE 50	953-XXXX	SLICE Ø20 * Ø10	953-00-2004					
ORIFICE P TYPE 60	953-XXXX	DISTANCE	953-00-2003					
LOCKING RING FOR ORIFICE P	953-0000-51	EYE BOLT	953-00-300					
LOCKING RING FOR CAR. DN50-80	953-00-100							



# 955 Flowmaster™ FC

## Motorized 2-way on/off dynamic balancing valve

Offers dynamic flow balancing and on/off control of fan coils – all in one – ensuring that the correct flow is maintained across all units

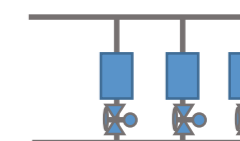

**Recommended application:**  
The 955 Flowmaster™ FC is installed on the return pipe of any fancoil. The correct flow cartridge is chosen based on flow requirements.

### Highlights

**Two in one**  
Two in one on/off control valve and dynamic flow balancing valve

**Exchange cartridge**  
Exchangeable cartridges for high/low flow and variable flow rates

**Silent**  
ICV thermo-electric actuator and internal diaphragm ensures silent operation preferred for hotels and homes

**Materials**  
Cap DZR Brass CW602N  
Body DZR Brass CW602N  
Cartridge DZR Brass CW602N  
Stem:Stainless steel  
Actuator housing ABS

ICV Flowmaster™ FC is a premium offering for on/off control as well as dynamic flow balancing.

The ICV Flowmaster™ FC is designed for the balancing of cooling and heating units. With its simple on/off control the valve can be used for many different applications, and at the same time advantage is derived from the dynamic control principles.

By means of ICV Flowmaster™ FC the optimum flow rate is ensured in each control area. This flow rate is maintained in spite of pressure fluctuations in the system. A control area may be two fan coils for a hotel room or a calorifier for a sports centre. Energy savings due to automatic flow control, lower flow and pump pressure. Maximized  $\Delta T$  due to faster response and increased system stability is also achieved.

Fan coils						
$\Delta p_{s}$ 380 kPa	Force (N)	Stroke	IP	955-000-9901	955-000-9902	955-000-9903
$\Delta p_{max}$ 230 kPa	130N	4mm	IP40/44	24 VAC	110 VAC	220 VAC
PN25 -10° to 120°C	ICV No. (L/H)	Flow (l/s)	Min $\Delta p$ (kPa)	ICV No. (L/H)	Flow (l/s)	Min $\Delta p$ (kPa)
	952-10 1 1150	0.007	7	952-11 1/2 1725	0.171	14
	952-10 1 1170	0.01	7	952-11 1/2 1730	0.186	14
	952-10 1 1190	0.012	7	952-11 1/2 1735	0.204	14
	952-10 1/2 1210	0.015	7	952-11 1/2 1740	0.222	16
	952-10 1/2 1230	0.021	8	952-11 1/2 1745	0.242	19
	952-10 1/2 1260	0.024	9	952-11 1/2 1750	0.26	21
	952-10 1/2 1290	0.029	10	AVK No. (L/H)	Flow (l/s)	Min $\Delta p$ (kPa)
	952-10 1/2 1300	0.032	10	952-20 1/2 2070	0.283	22
	952-10 1/2 1320	0.036	11	952-20 1/2 2074	0.3	22
	952-10 1/2 1350	0.043	11	952-20 1/2 2077	0.332	22
	952-10 1/2 1370	0.049	12	952-20 1/2 2082	0.371	23
	952-10 1/2 1400	0.057	12	952-20 1/2 2086	0.412	23
	952-10 1/2 1430	0.067	12	952-20 1/2 2088	0.439	23
	952-10 1/2 1460	0.078	12	952-20 1/2 2092	0.493	24
	952-10 1/2 1490	0.089	13	952-20 1/2 2094	0.509	24
	952-10 1/2 1510	0.097	13	952-20 1/2 2099	0.578	25
	952-10 1/2 1540	0.111	13	952-20 1/2 2103	0.625	26
	952-10 1/2 1570	0.132	14	952-20 1/2 2106	0.644	27
	952-10 1/2 1620	0.151	14	952-20 1/2 2109	0.68	28

955-015-20-1  
955-020-20-1  
955-025-20-1